

CH704

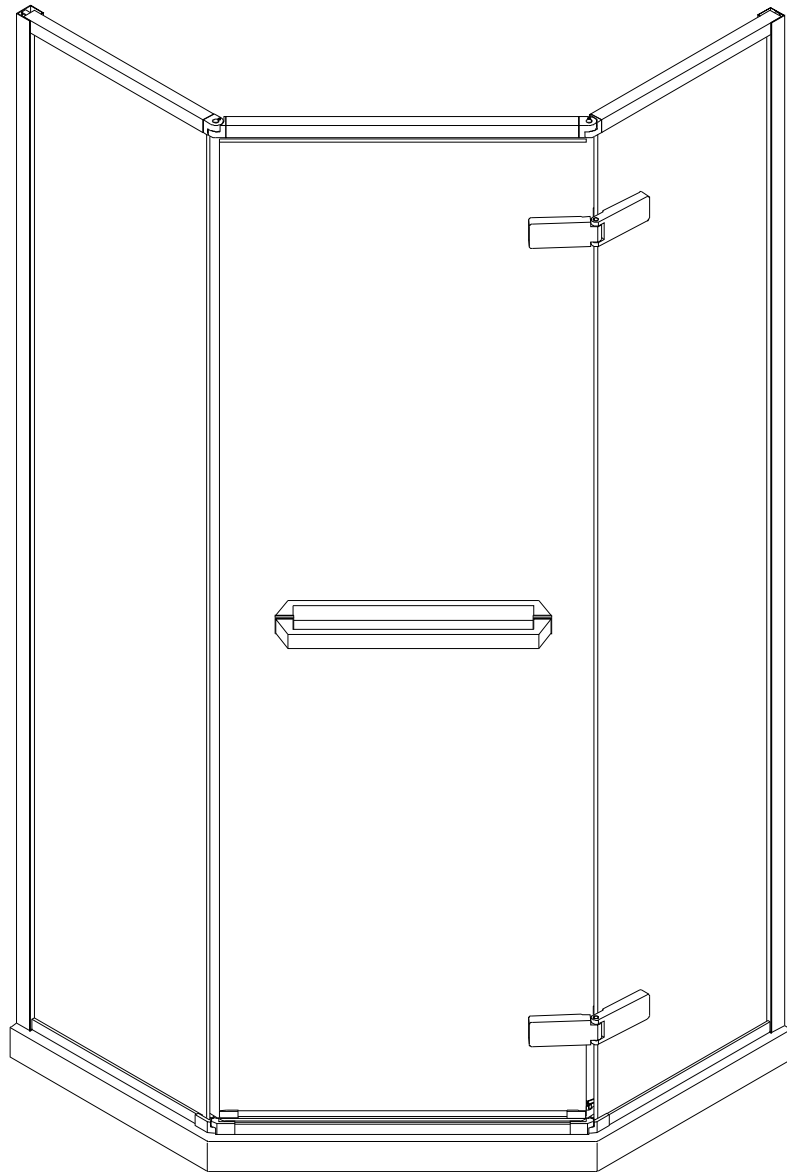

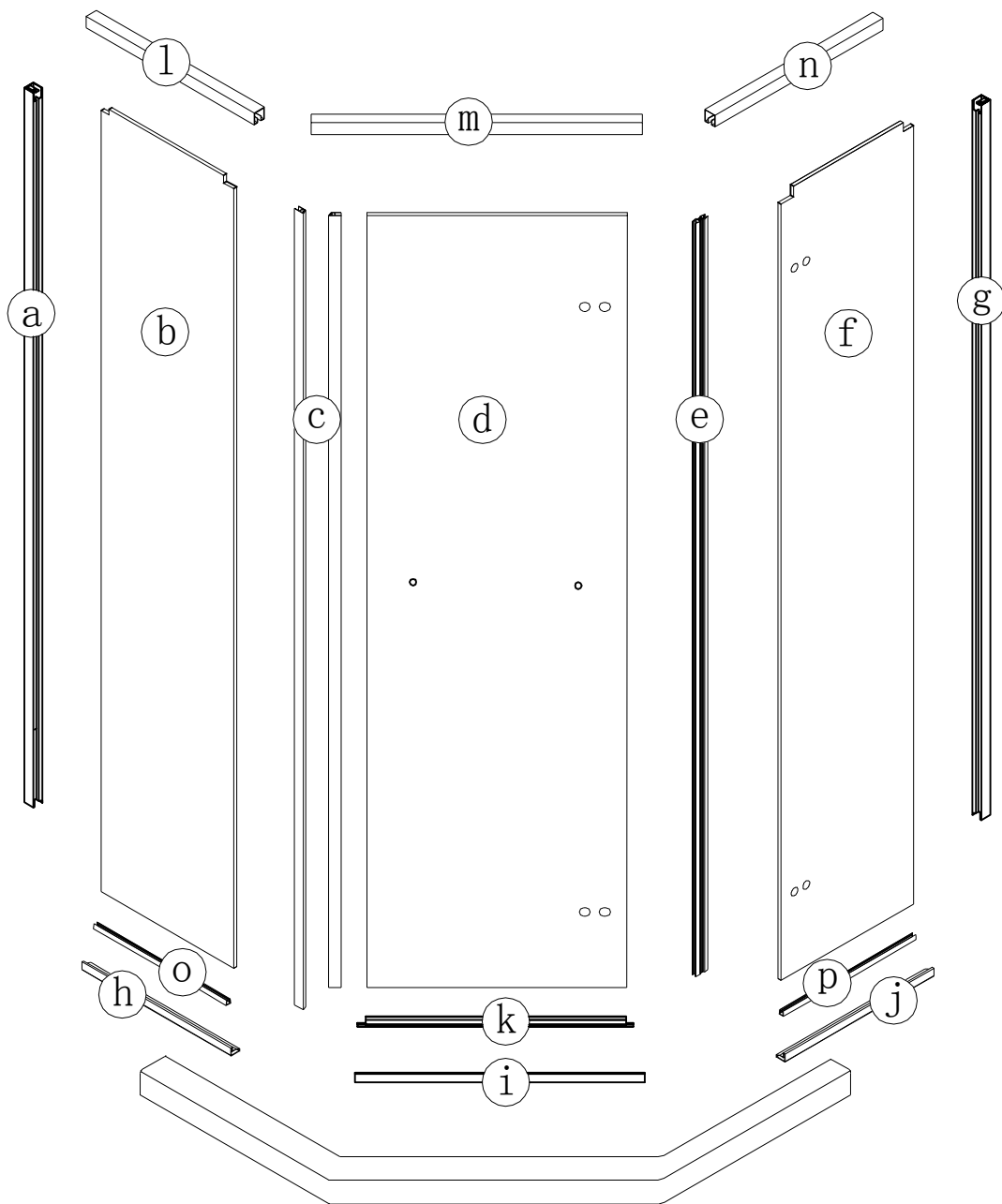

14

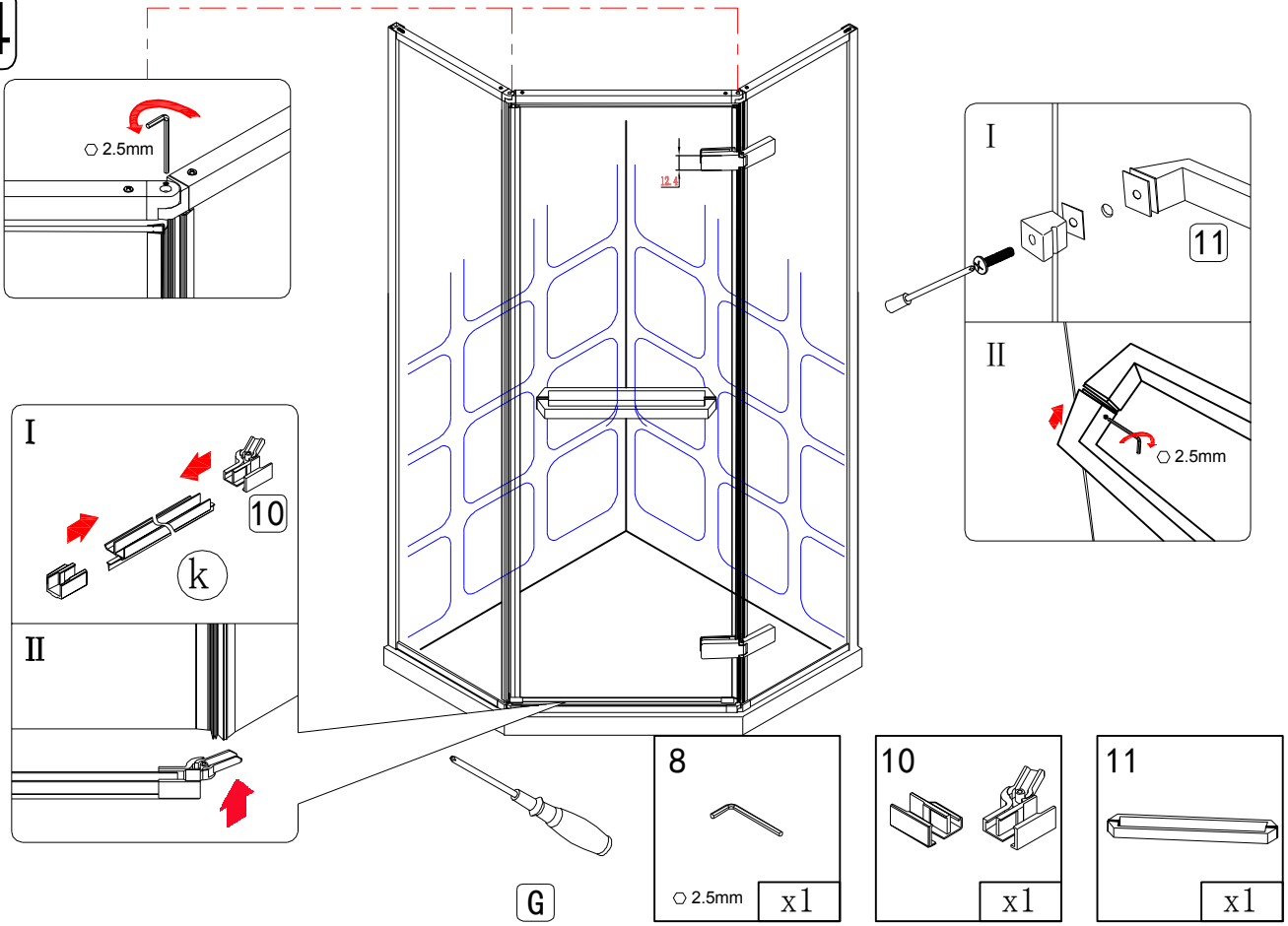

15

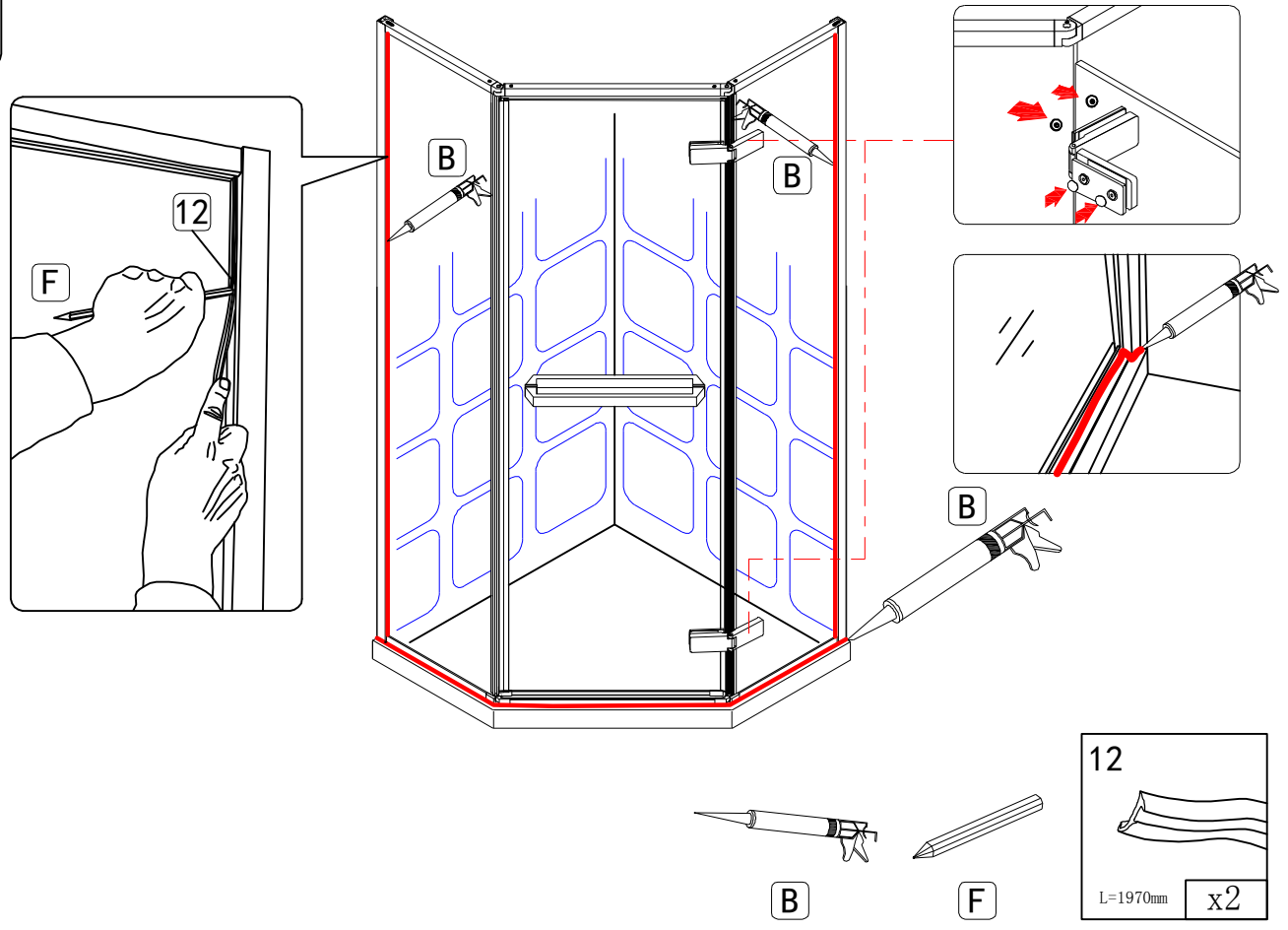

12

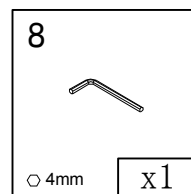
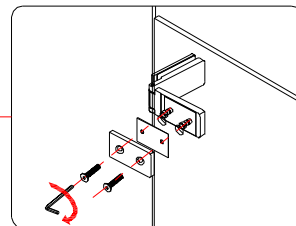
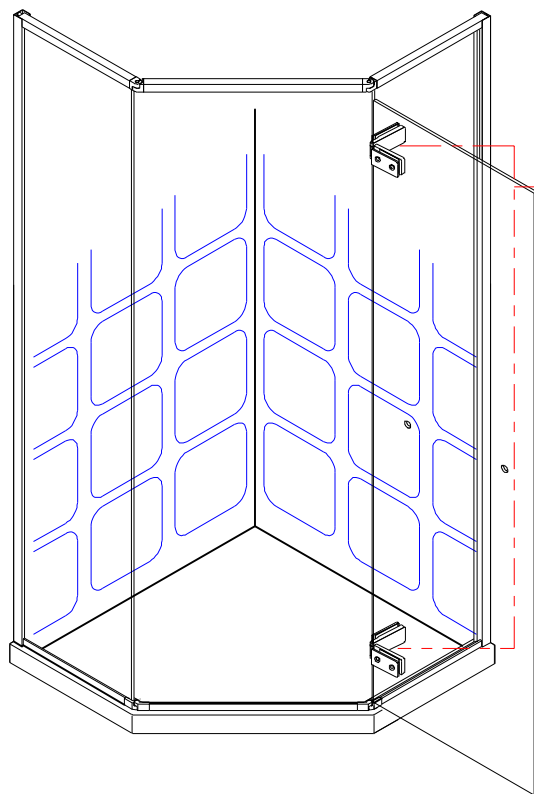

13

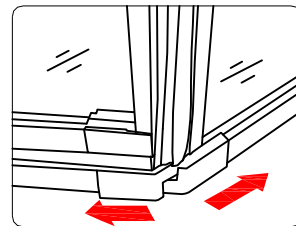
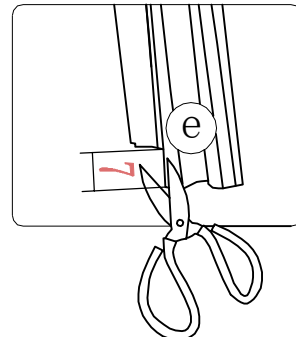
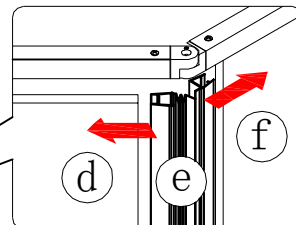
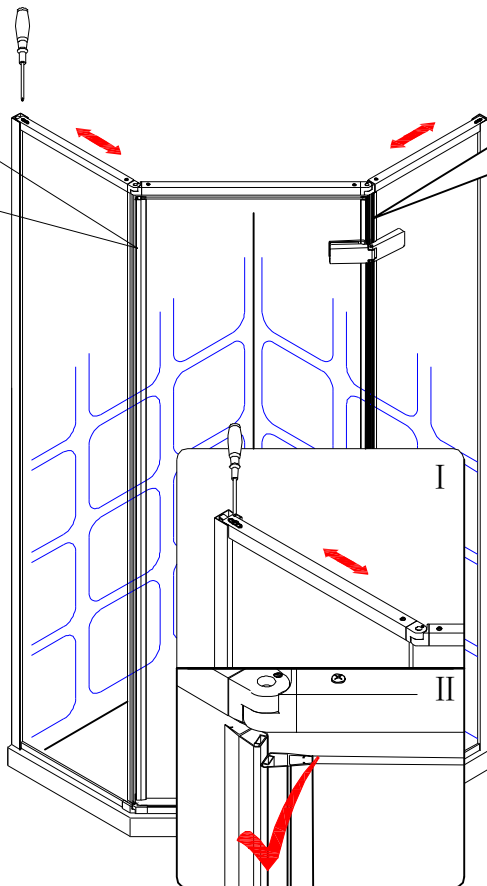
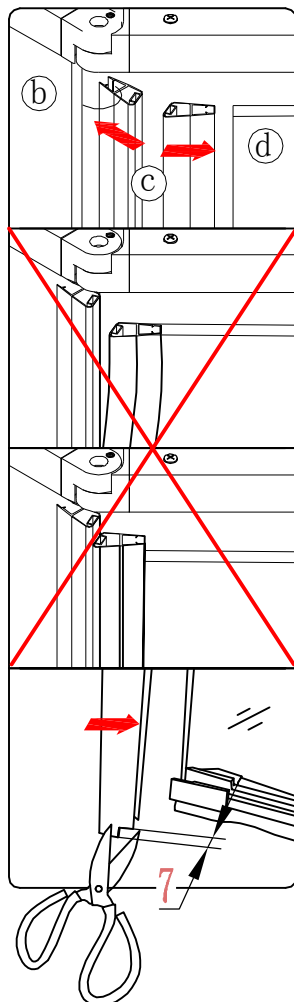

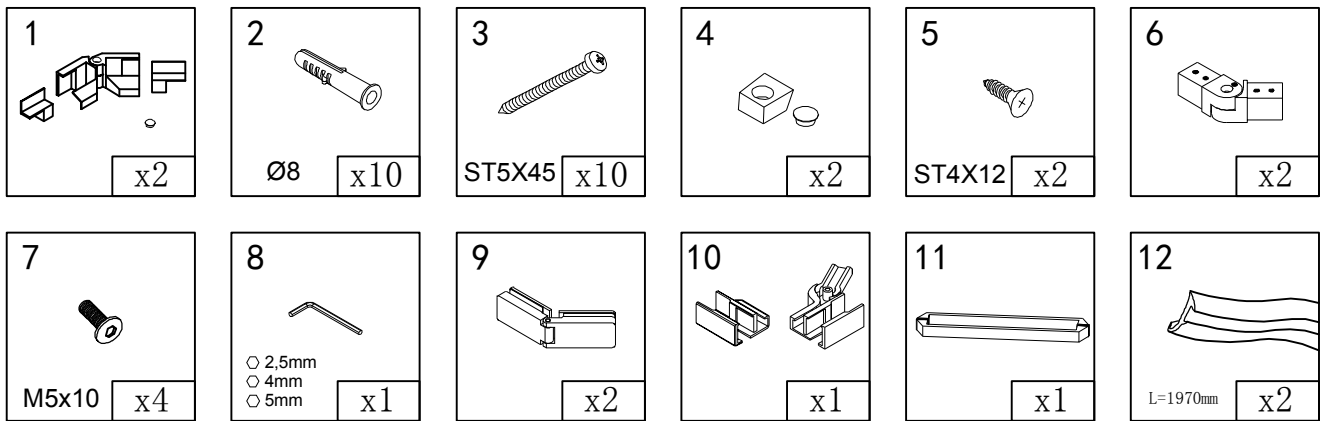
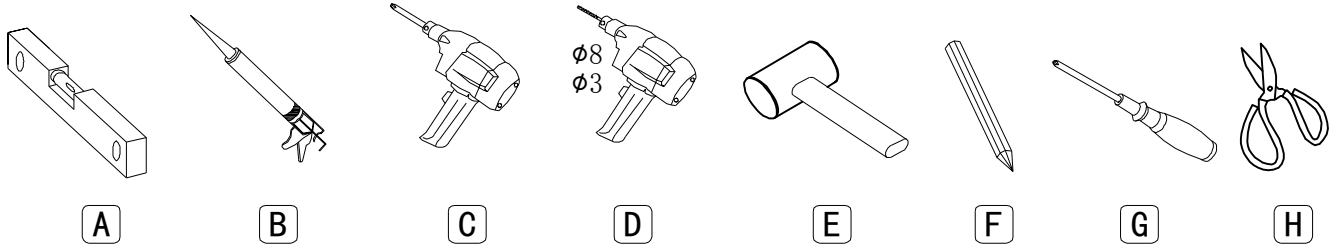
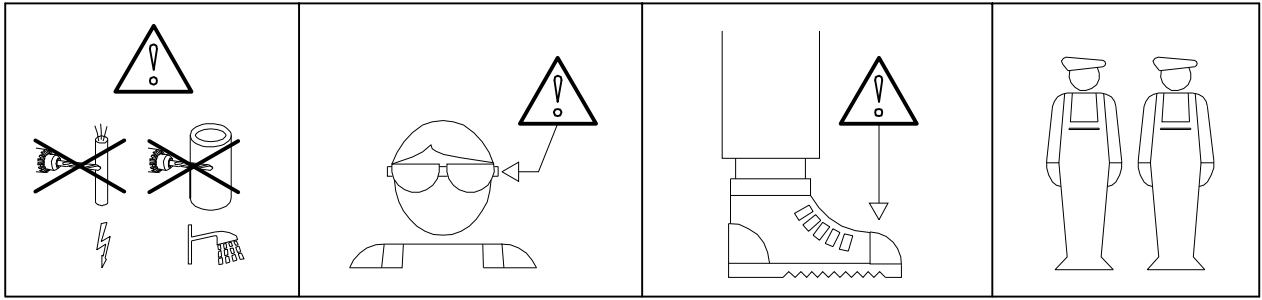

1

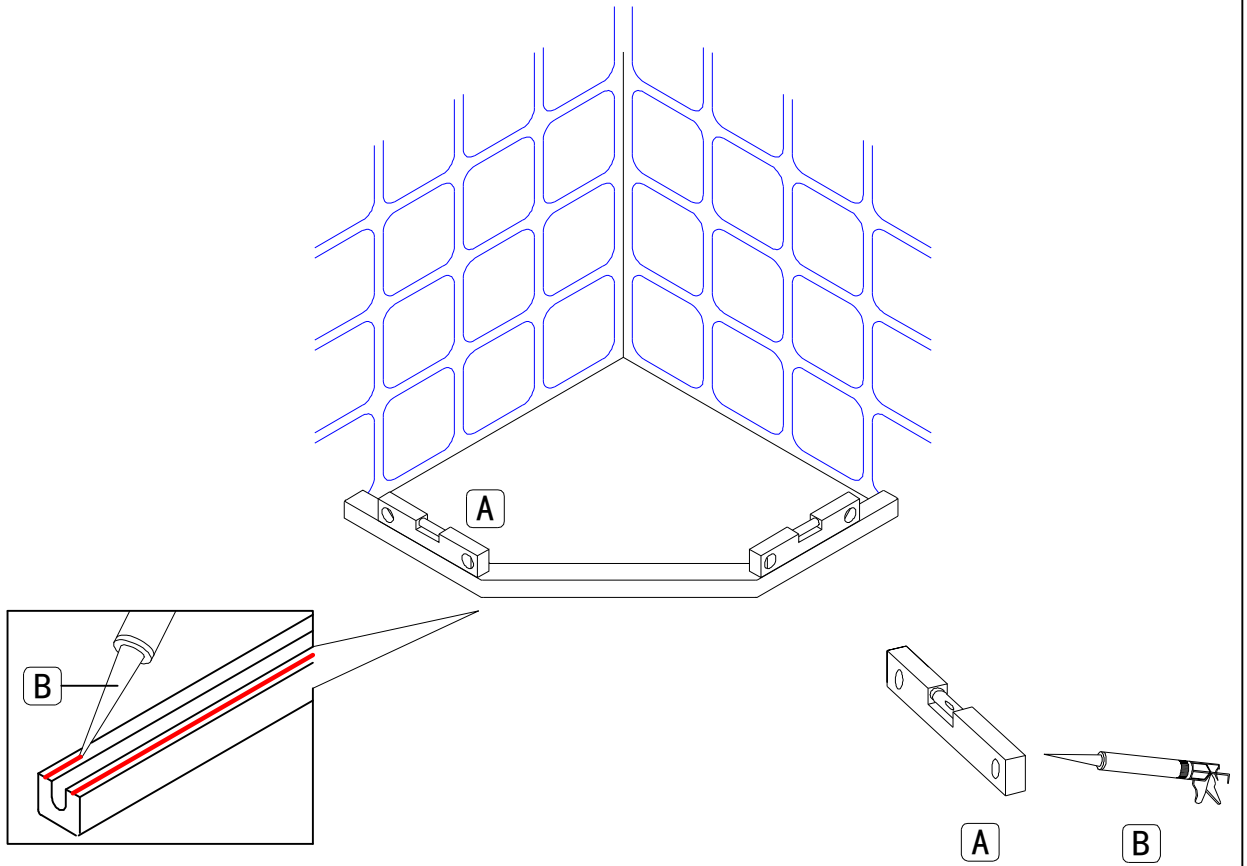

2

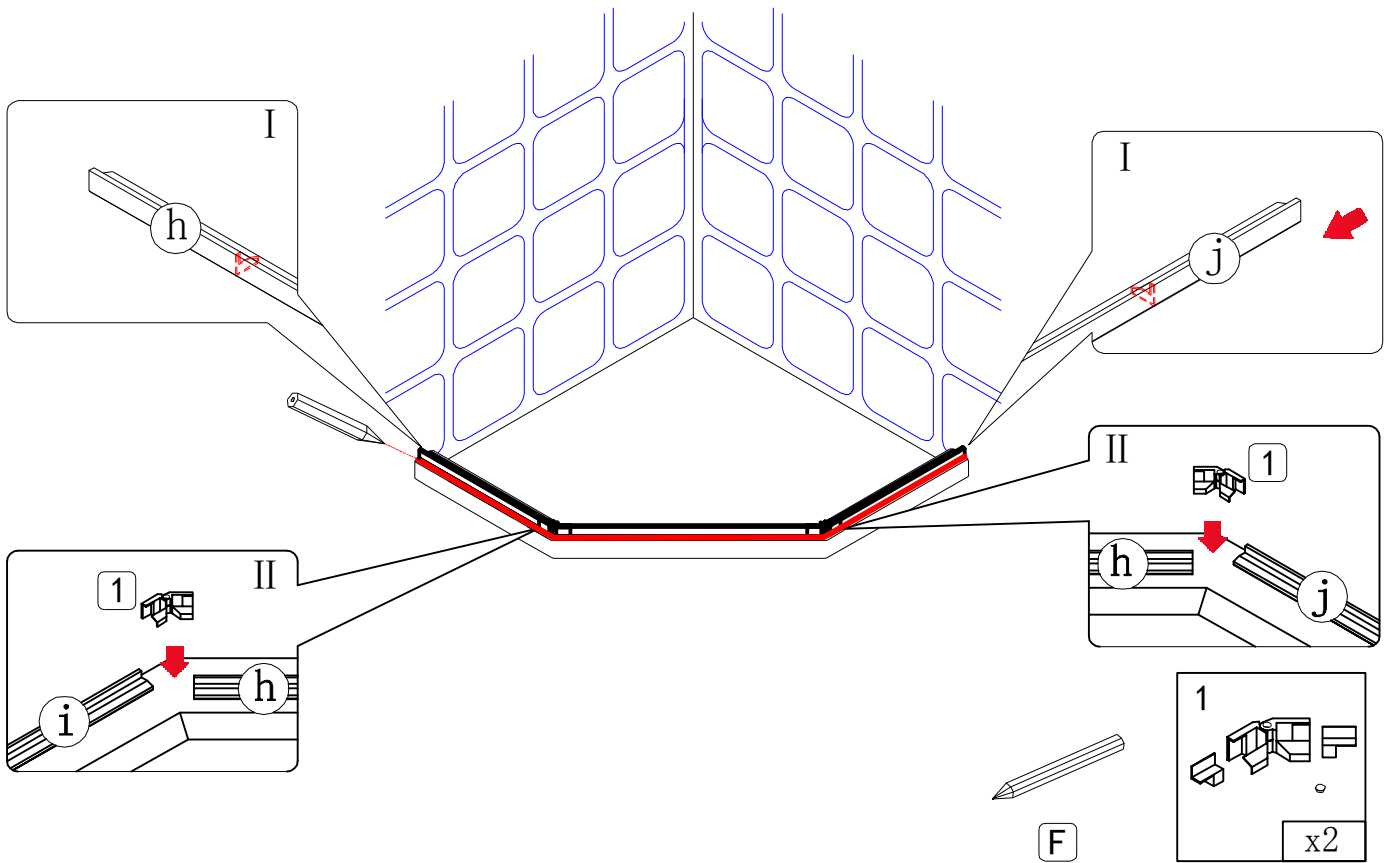

3

10

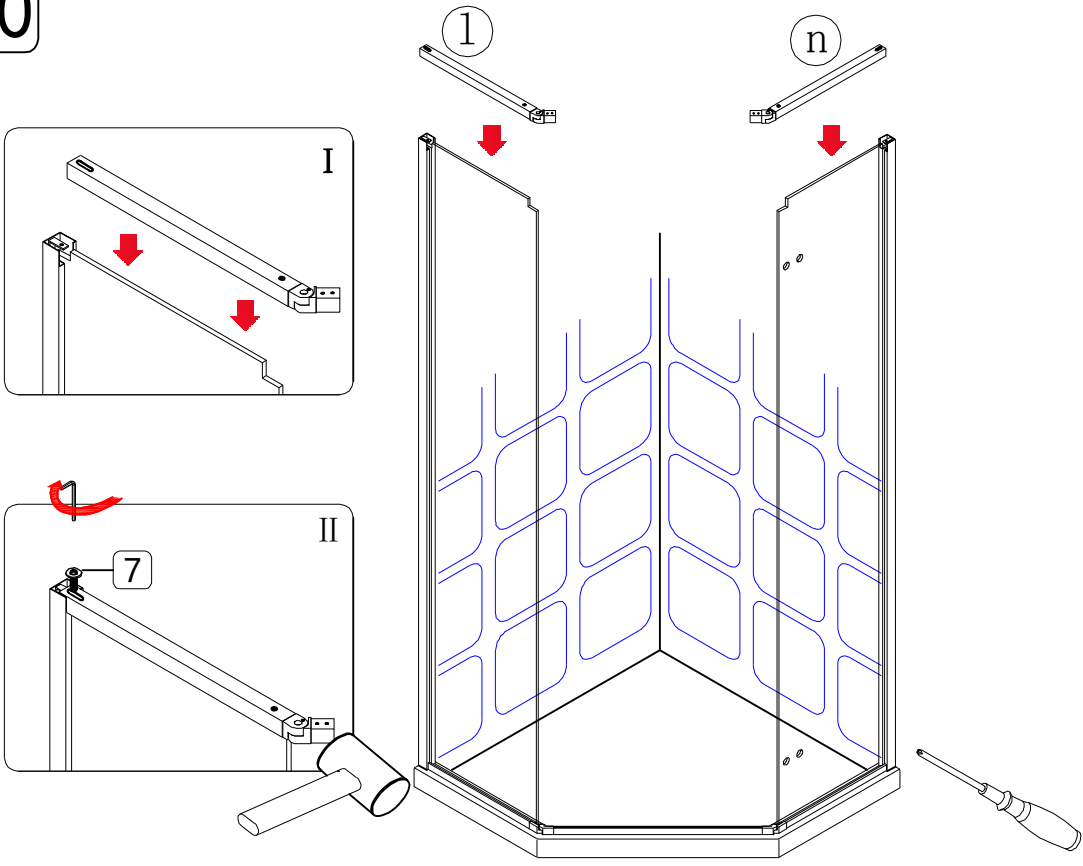



G

7

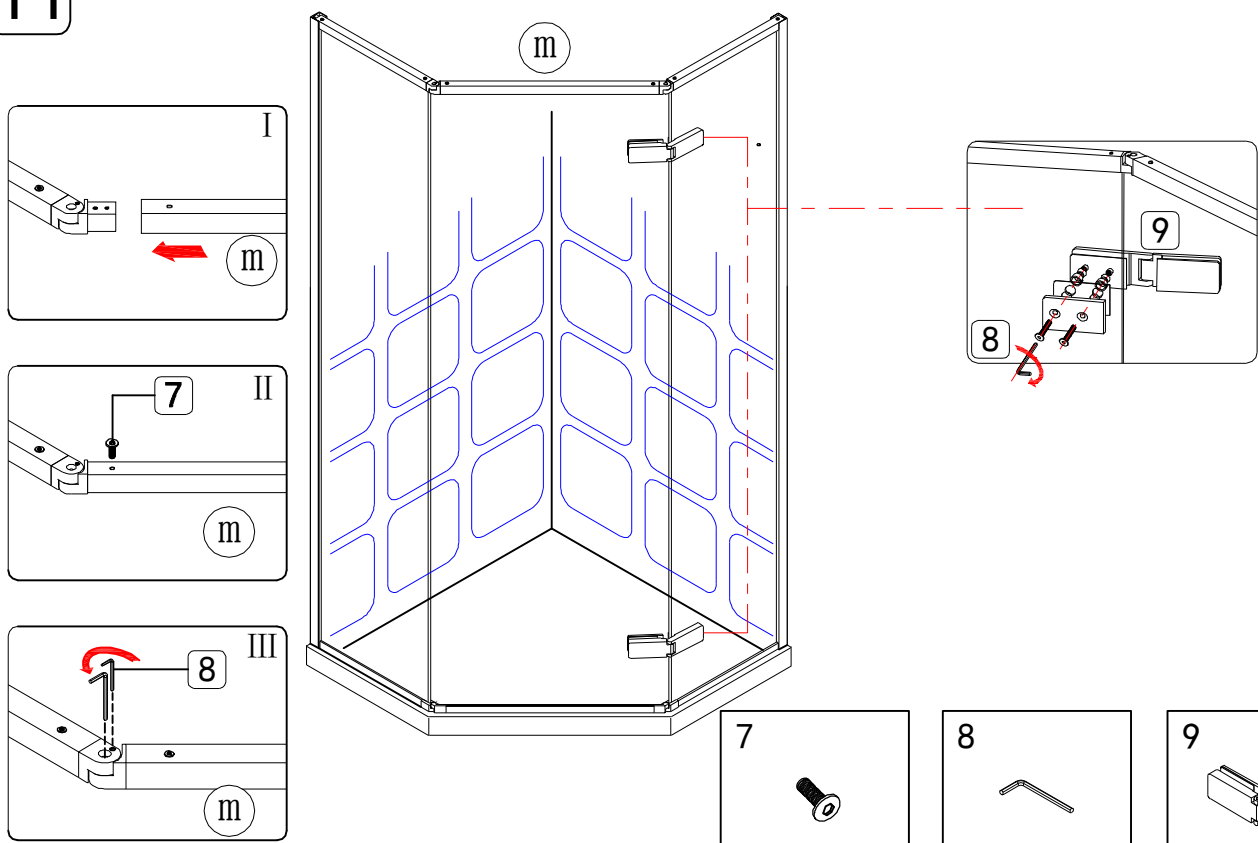
M5x10
x2

11

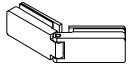

7

M5x10
x2

8

4mm
x1

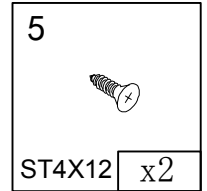
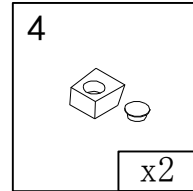
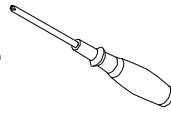
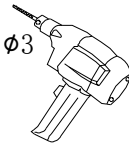
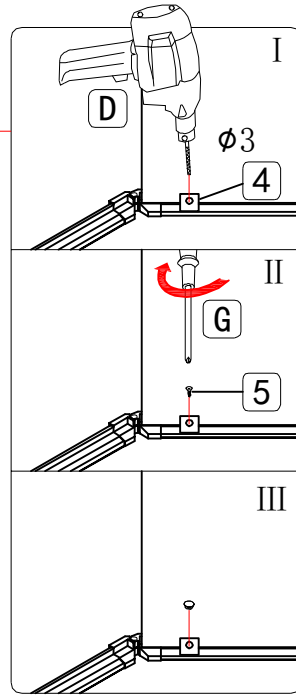
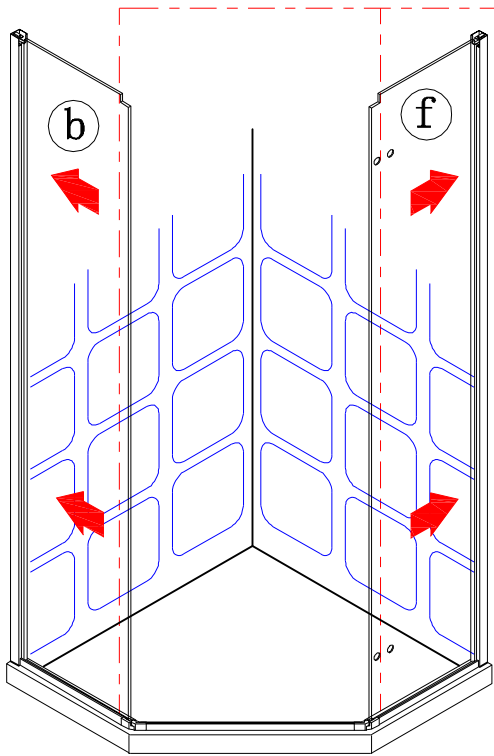
9

x2

8

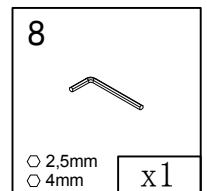
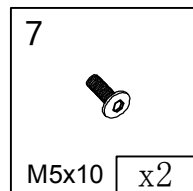
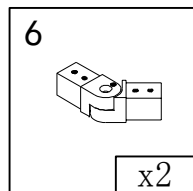
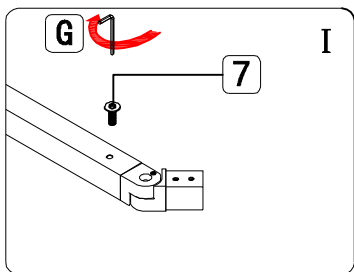
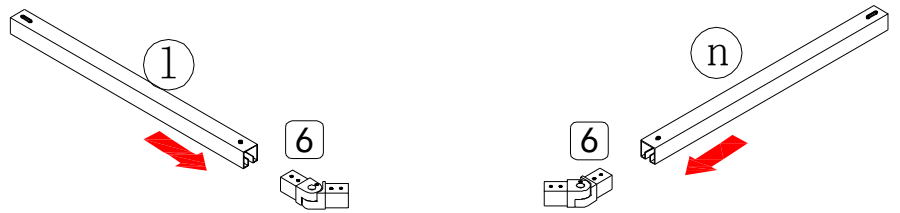

9



3

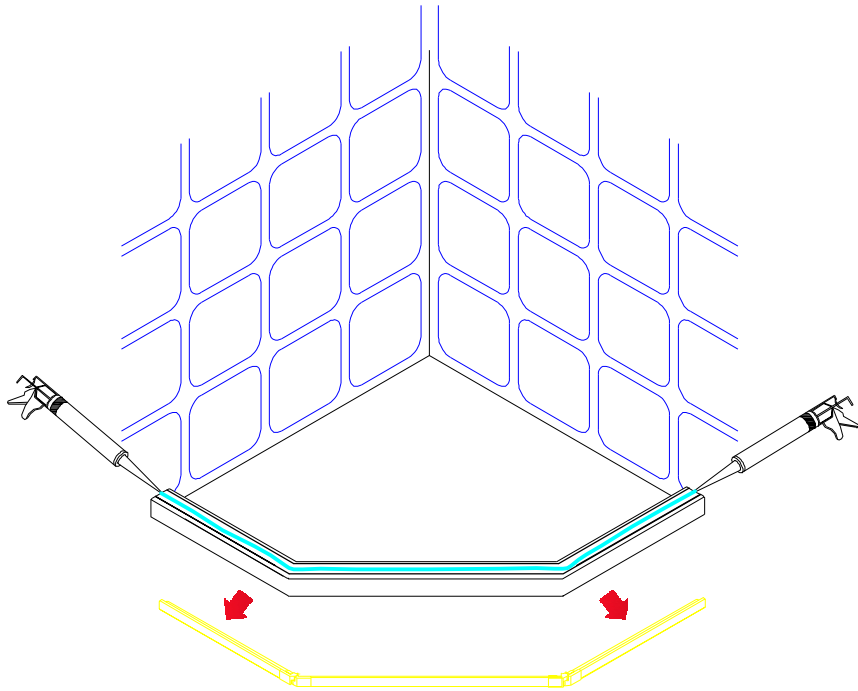

B

4

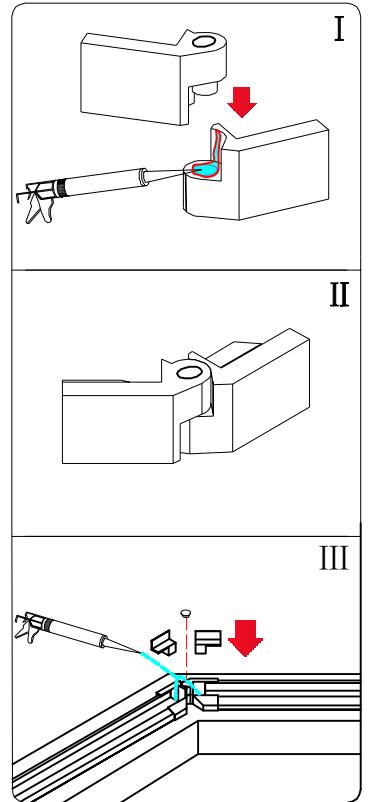
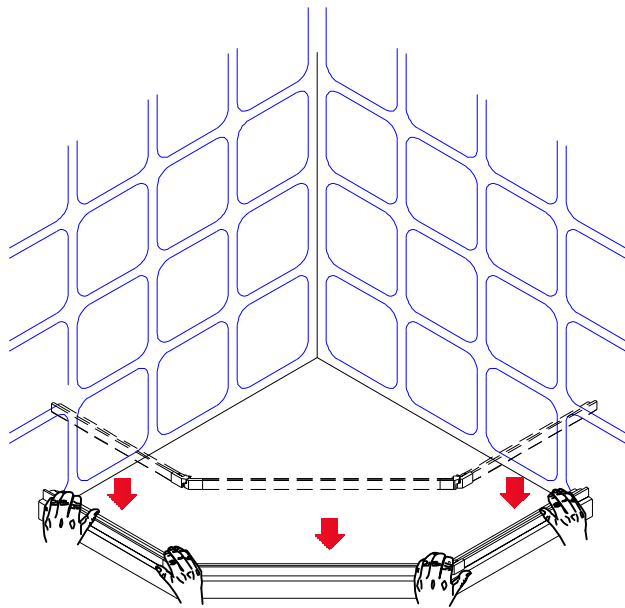

B

5

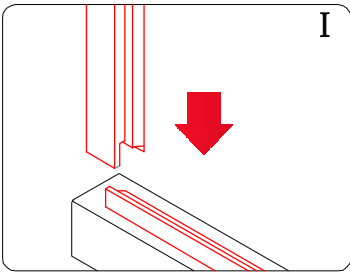

I

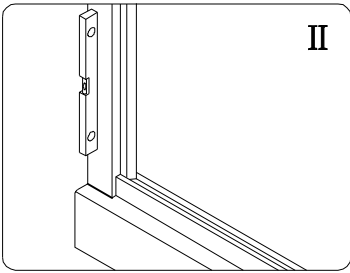

II

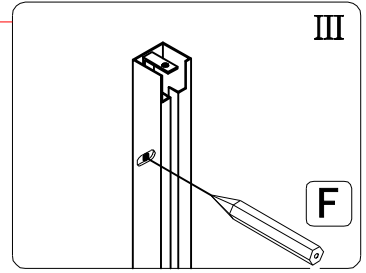
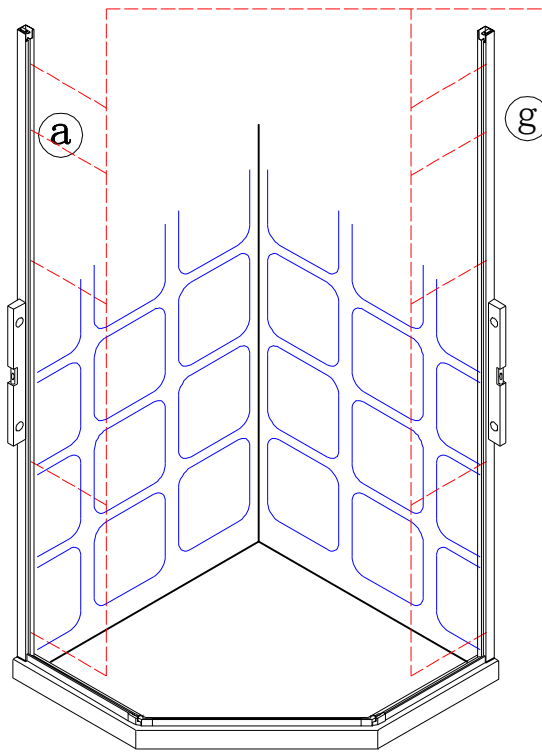

III

F

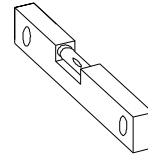

A

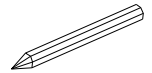

F

6

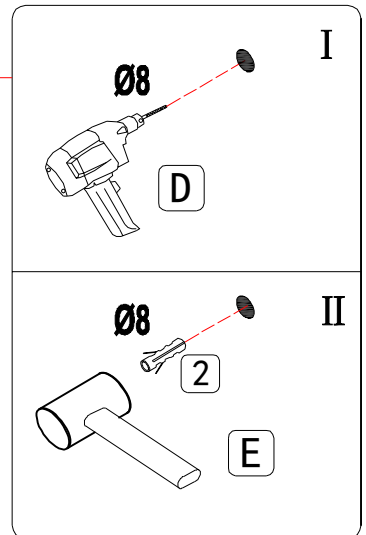
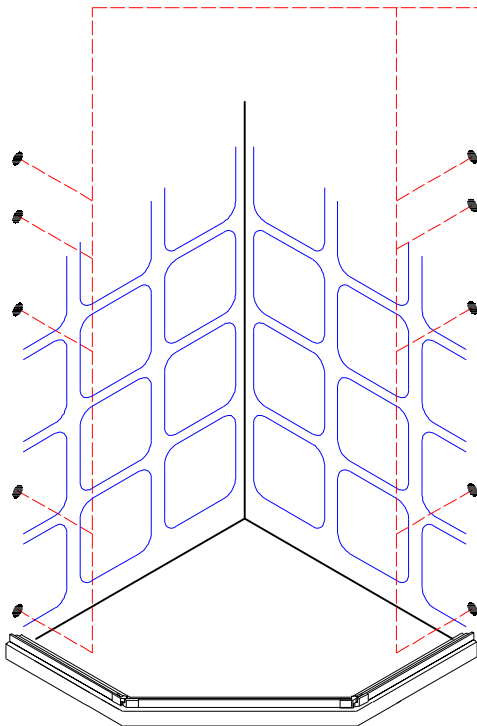

I

D

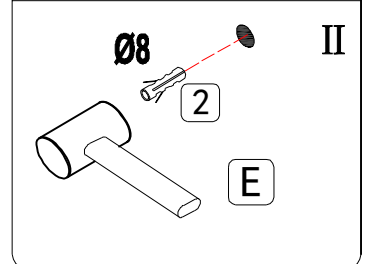

II

2

E

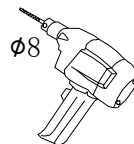

D

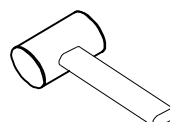

E

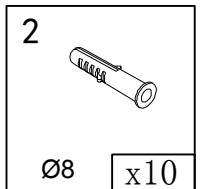

2

$\varnothing 8$

x10

6

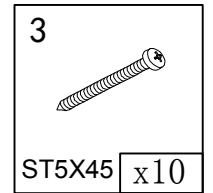
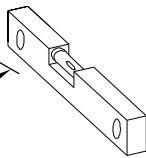
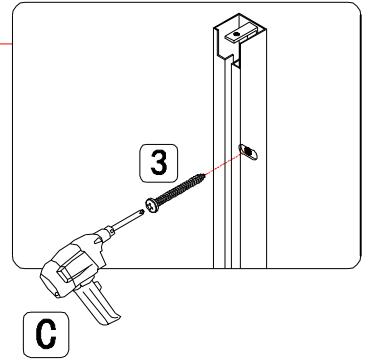
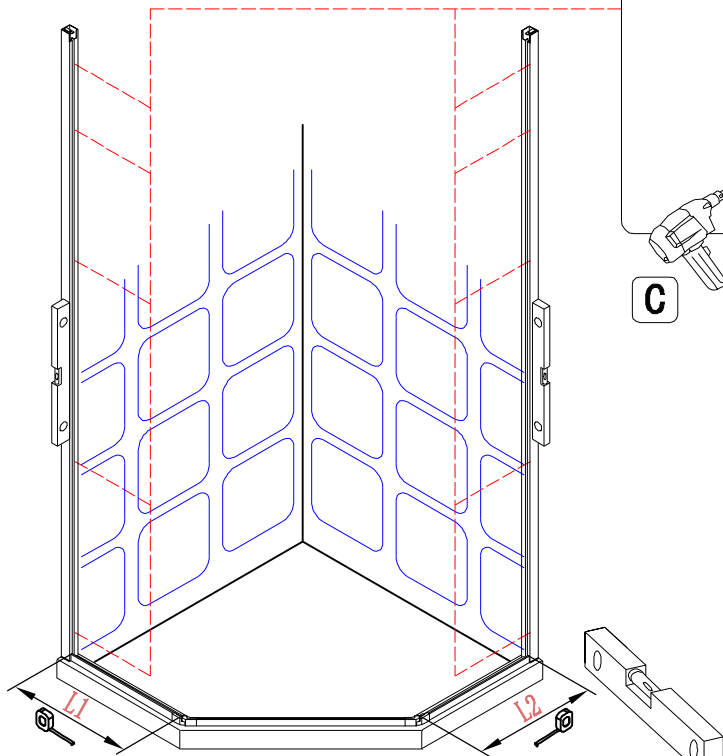

A

C

7

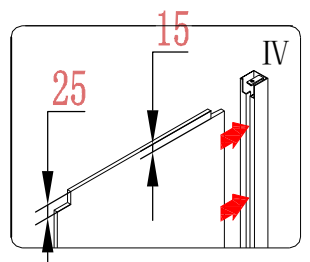
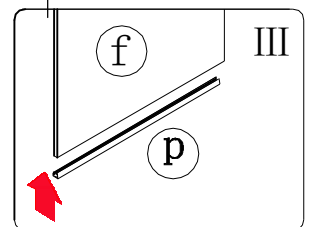
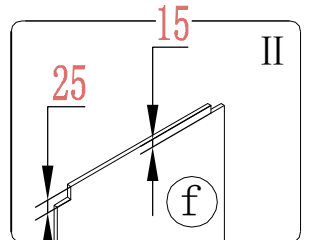
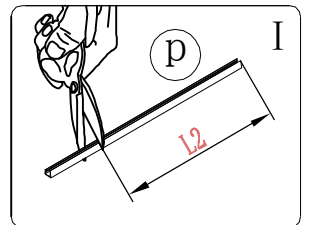
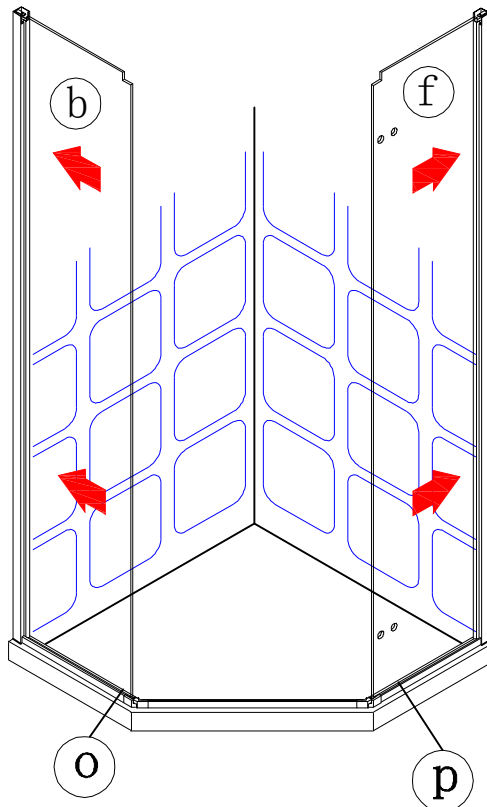
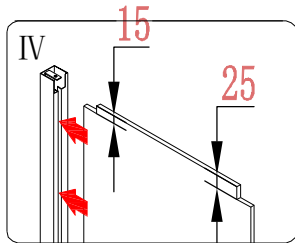
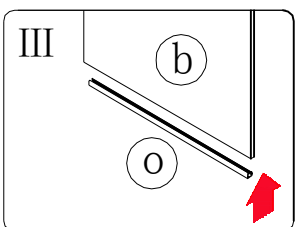
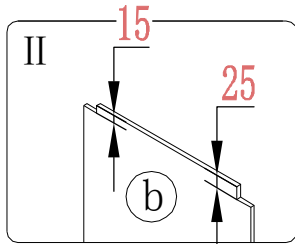
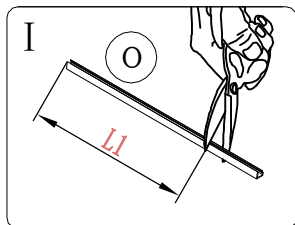

6